

GP/LP Communication Cable

Ordering information

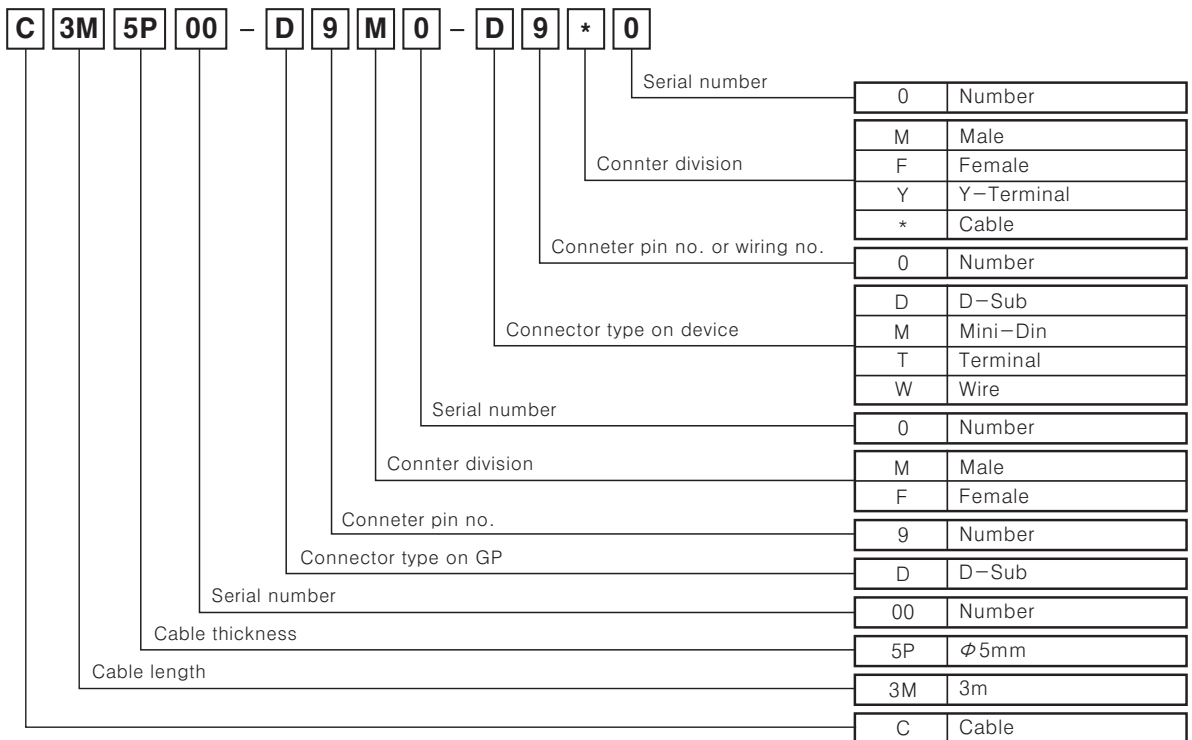

Communication cable wiring and dimensions

1. C3M5P00-D9F0-M6M0

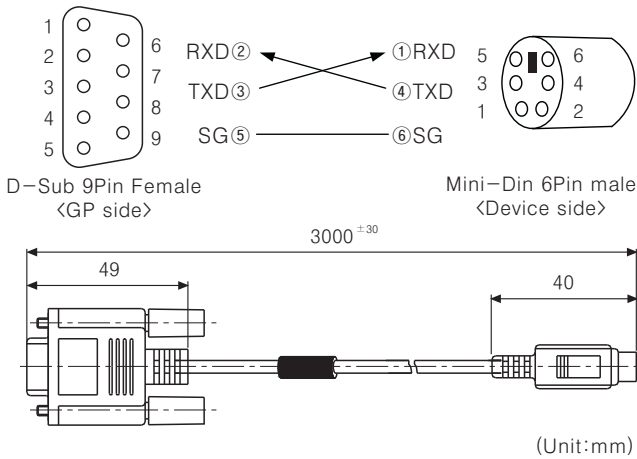

3. C3M5P02-D9F0-D9M0

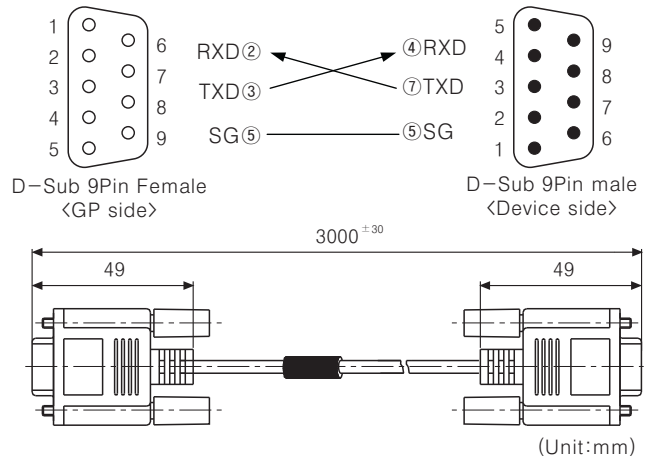

2. C3M5P01-D9F0-D9M0

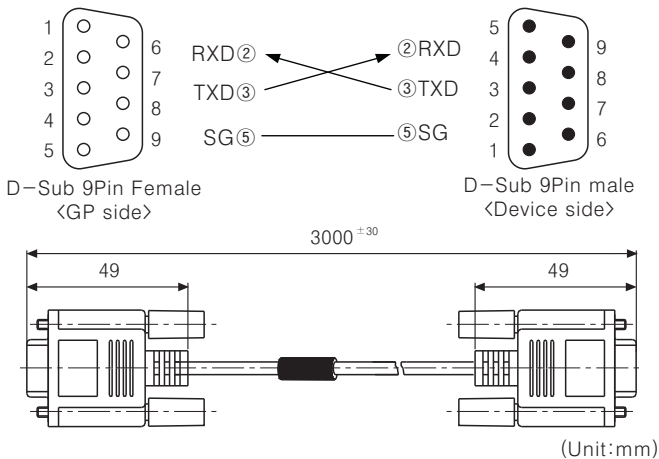

4. C3M5P03-D9M0-W4*0

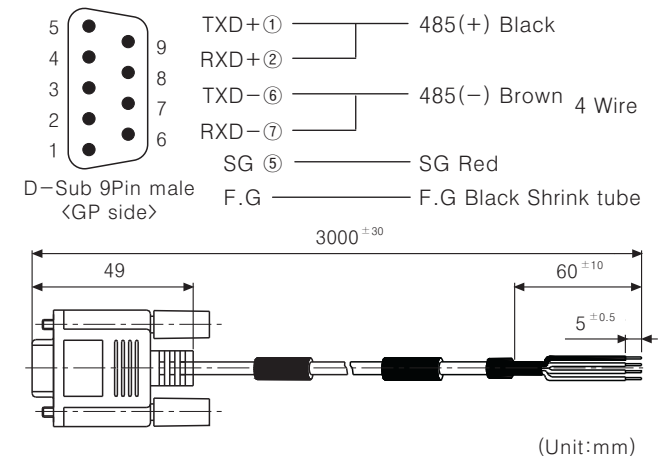

GP/LP Communication Cable

■ Communication cable wiring and dimensions

5. C3M5P04-D9M0-W6*0

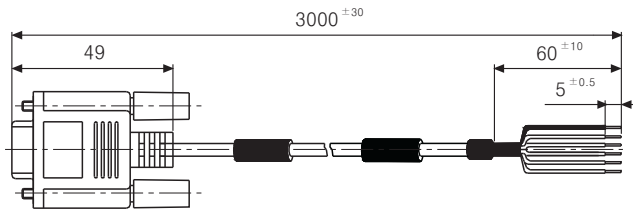
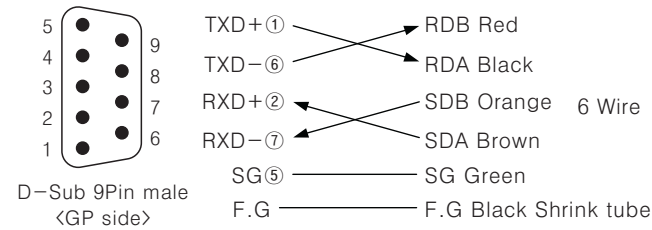

(Unit:mm)

8. C3M5P07-D9F0-D9M0

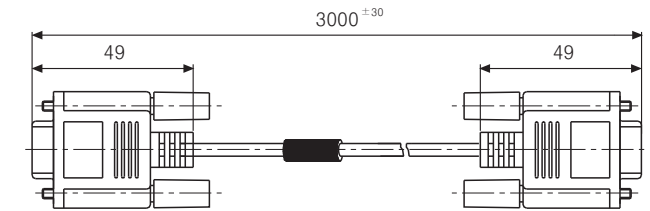

(Unit:mm)

6. C3M5P05-D9F0-D9M0

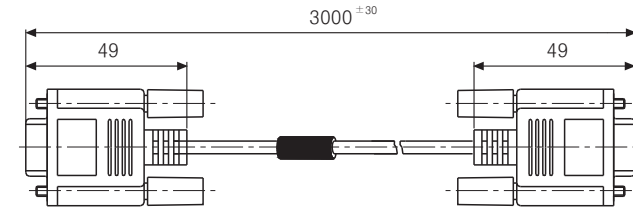
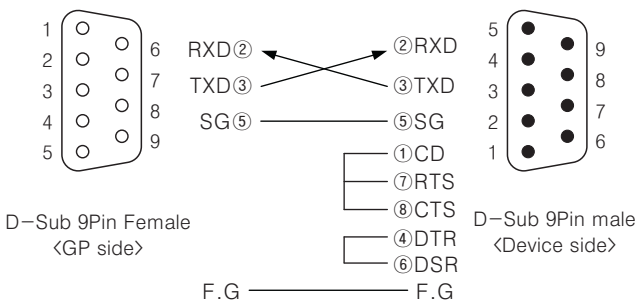

(Unit:mm)

9. C3M5P08-D9F0-M8M0

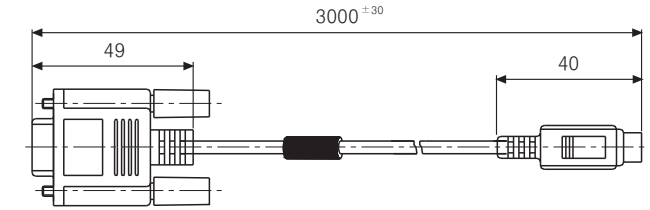
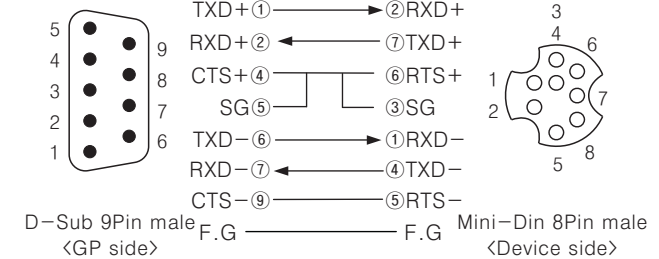

(Unit:mm)

7. C3M5P06-D9F0-D15M0

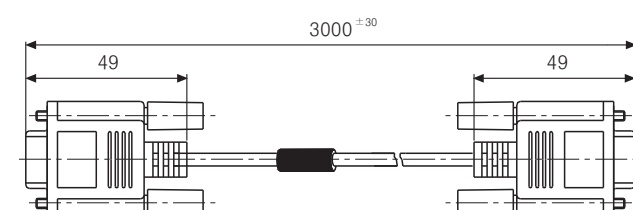
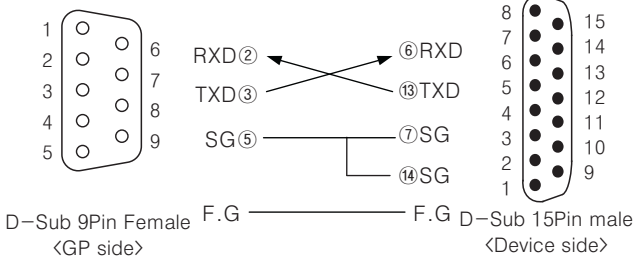

(Unit:mm)

10. C3M5P09-D9F0-D9F0

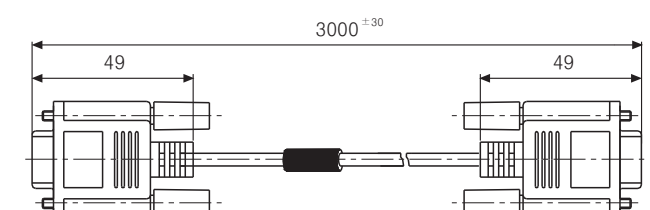
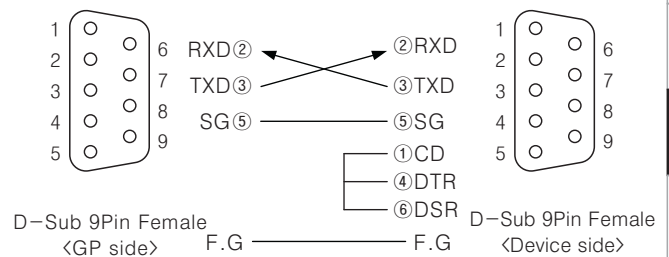

(Unit:mm)

(A)	Photo electric sensor
(B)	Fiber optic sensor
(C)	Door/Area sensor
(D)	Proximity sensor
(E)	Pressure sensor
(F)	Rotary encoder
(G)	Connector/Socket
(H)	Temp. controller
(I)	SSR/ Power controller
(J)	Counter
(K)	Timer
(L)	Panel meter
(M)	Tacho/ Speed/ Pulse meter
(N)	Display unit
(O)	Sensor controller
(P)	Switching power supply
(Q)	Stepping motor & Driver & Controller
(R)	Graphic/ Logic panel
(S)	Field network device
(T)	Production stoppage models & replacement

GP/LP Communication Cable

■ Communication cable wiring and dimensions

11. C3M5P10-D9F0-M5M0

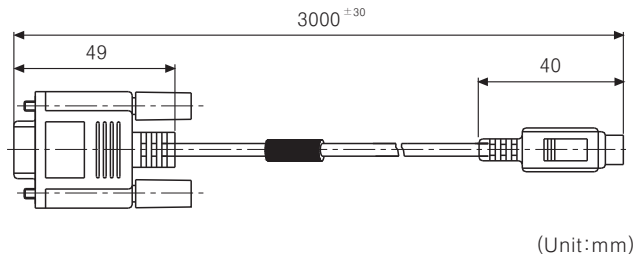
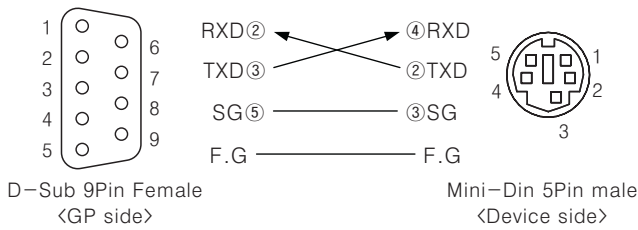

14. C3M5P13-D9F0-T4Y0

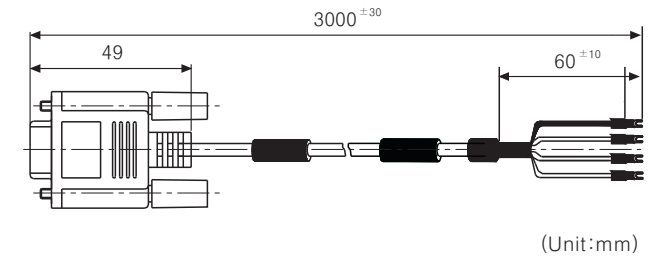
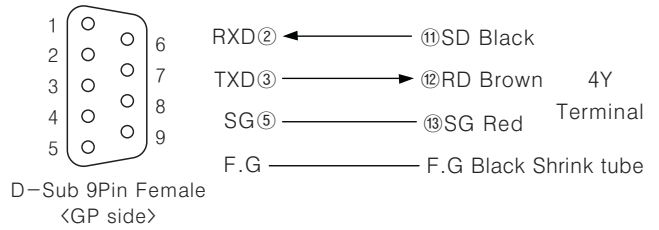

12. C3M5P11-D9F0-W4*0

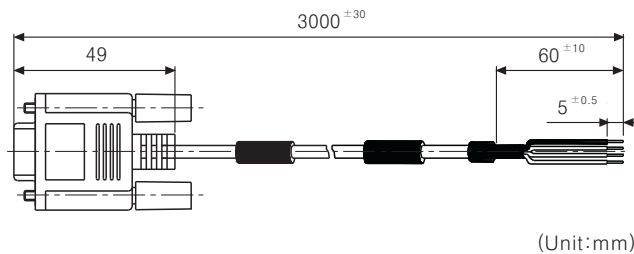
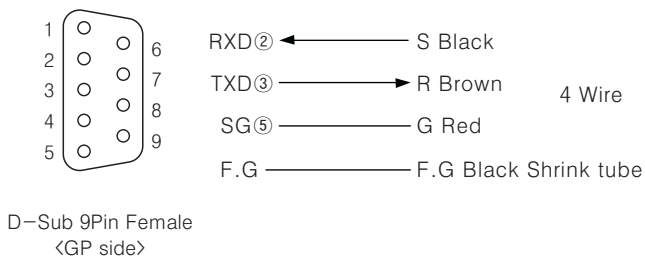

15. C3M5P03-D9M0-T4Y0

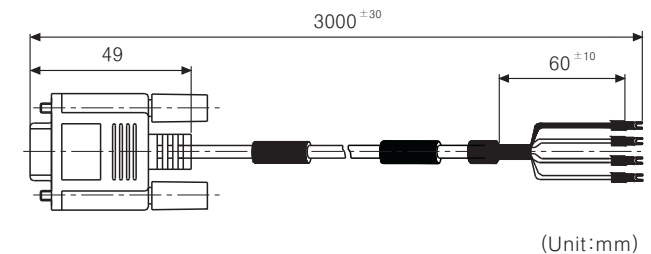
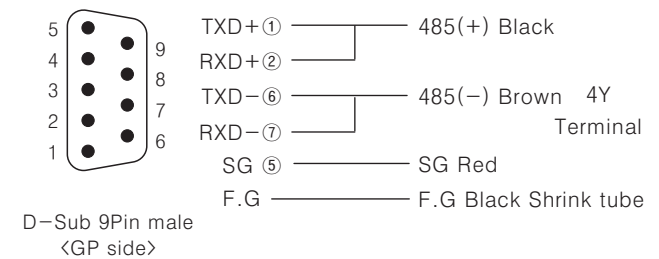

13. C3M5P12-D9F0-D9M1

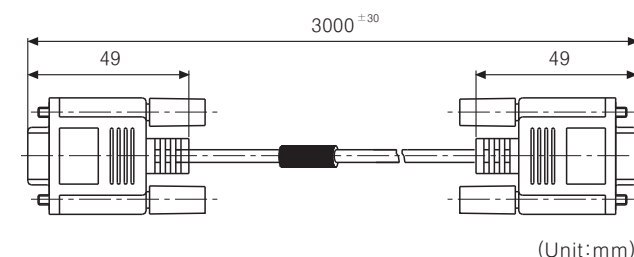
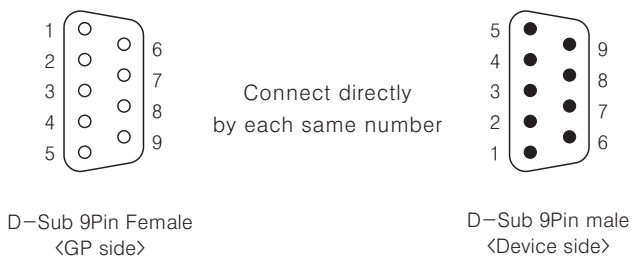

16. C3M5P04-D9M0-T6Y0

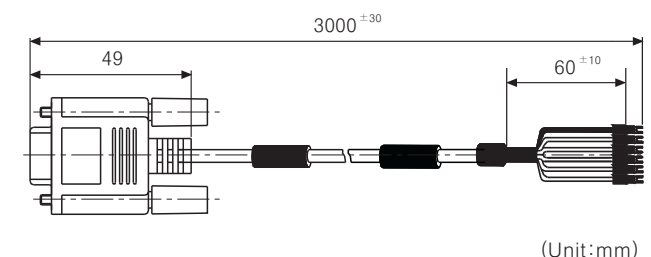
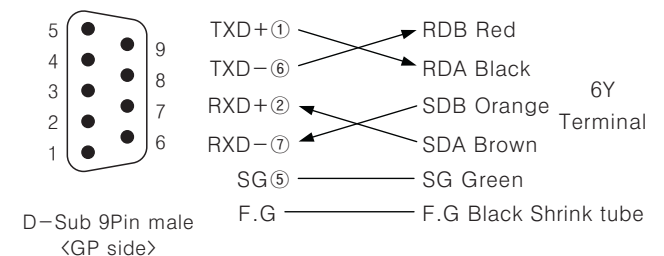

GP/LP Communication Cable

■ Communication cable wiring and dimensions

17. C3M5P14-D9F0-D9F0

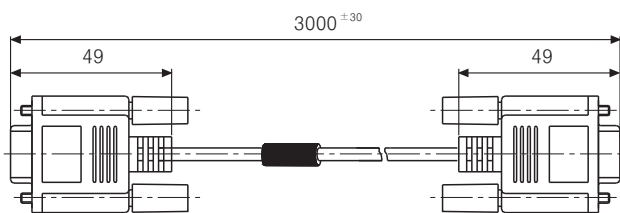
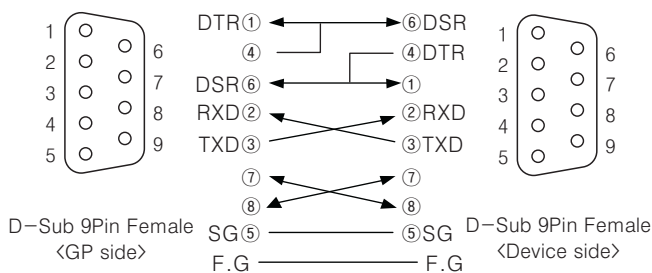

18. C3M5P15-D9M0-D9M0

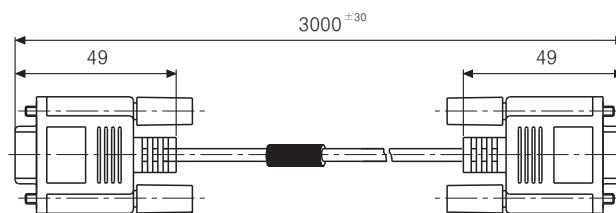
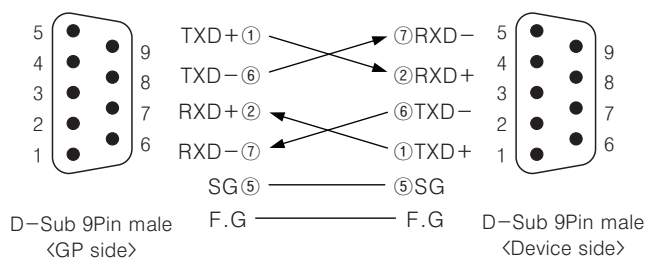

19. C3M5P08-D9M0-M8M1

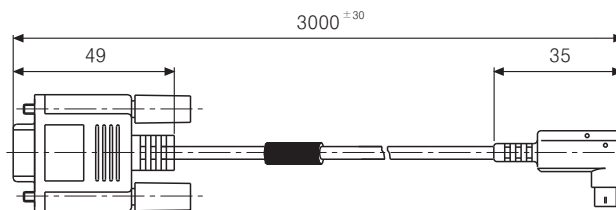
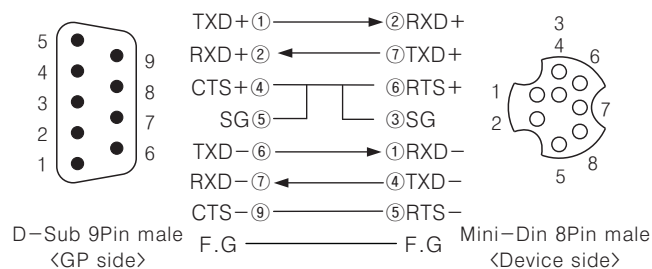

■ Communication cable by connectable device

Series	Connectable device	Connectable module	Connection type	Communication cable model	Connection diagram no.
LS Master-K	MK-10S1	CPU	RS232C	C3M5P00-D9F0-M6M0	1
	MK-80S	CPU	RS232C	C3M5P01-D9F0-D9M0	2
	MK-120S	CPU	RS232C	C3M5P01-D9F0-D9M0	2
	MK-200S	CPU	RS232C	C3M5P01-D9F0-D9M0	2
	MK-300S	CPU	RS232C	C3M5P01-D9F0-D9M0	2
	MK-1000S	CPU	RS232C	C3M5P01-D9F0-D9M0	2
LS Glofa	GM4	CPU	RS232C	C3M5P01-D9F0-D9M0	2
	GM6	CPU	RS232C	C3M5P01-D9F0-D9M0	2
	GM7U	CPU	RS232C	C3M5P01-D9F0-D9M0	2
LS Master-K CNET	MK-80S	Cnet module(G7L-CUEB)	RS232C	C3M5P05-D9F0-D9M0	6
		Cnet module(G7L-CUEC)	RS422	C3M5P04-D9M0-T6Y0	16
	MK-120S	CPU	RS232C	C3M5P02-D9F0-D9M0	3
		CPU	RS485	C3M5P03-D9M0-W4*0	4
		Cnet module(G7L-CUEB)	RS232C	C3M5P05-D9F0-D9M0	6
		Cnet module(G7L-CUEC)	RS422	C3M5P04-D9M0-T6Y0	16
	MK-200S	CPU	RS232C	C3M5P02-D9F0-D9M0	3
		CPU	RS422	C3M5P04-D9M0-W6*0	5
		CPU	RS485	C3M5P03-D9M0-W4*0	4
		Cnet module(G6L-CUEB)	RS232C	C3M5P05-D9F0-D9M0	6
	MK-300S	G4L-CUEA	RS232C	C3M5P05-D9F0-D9M0	6
			RS422	C3M5P04-D9M0-T6Y0	16
MK-1000S	G3L-CUEA	RS232C	C3M5P05-D9F0-D9M0	6	
		RS422	C3M5P04-D9M0-T6Y0	16	
LS XGT CNET	XGK-CPUS	XGL-C22A	RS232C	C3M5P01-D9F0-D9M0	2
		XGL-CH2A	RS232C	C3M5P01-D9F0-D9M0	2
			RS422	C3M5P04-D9M0-T6Y0	16
		XGL-C42A	RS422	C3M5P04-D9M0-T6Y0	16

- (A) Photo electric sensor
- (B) Fiber optic sensor
- (C) Door/Area sensor
- (D) Proximity sensor
- (E) Pressure sensor
- (F) Rotary encoder
- (G) Connector/Socket
- (H) Temp. controller
- (I) SSR/Power controller
- (J) Counter
- (K) Timer
- (L) Panel meter
- (M) Tacho/Speed/Pulse meter
- (N) Display unit
- (O) Sensor controller
- (P) Switching power supply
- (Q) Stepping motor & Driver & Controller
- (R) Graphic/Logic panel
- (S) Field network device
- (T) Production stoppage models & replacement

GP/LP Communication Cable

■ Communication cable by connectable device

Series	Connectable device	Connectable module	Connection type	Communication cable model	Connection diagram no.
LS XGB CNET	XBM	CPU	RS232C	C3M5P13-D9F0-T4Y0	14
			RS485	C3M5P03-D9M0-T4Y0	15
	XBC	CPU	RS232C	C3M5P13-D9F0-T4Y0	14
			RS485	C3M5P03-D9M0-T4Y0	15
OEMAX (SAMSUNG)	N70	CPU	RS232C	C3M5P06-D9F0-D15M0	7
	N70 Plus	CPU	RS232C	C3M5P07-D9F0-D9M0	8
OEMAX FARA	NX7	CPU	RS232C	C3M5P07-D9F0-D9M0	8
	NX70	CPU	RS232C	C3M5P07-D9F0-D9M0	8
MITSUBISHI FX	FX1S	CPU	RS422	C3M5P08-D9F0-M8M0	9
		RS232C module(FX1S-232-BD)	RS232C	C3M5P09-D9F0-D9F0	10
	FX1N	CPU	RS422	C3M5P08-D9F0-M8M0	9
		RS232C module(FX1N-232-BD)	RS232C	C3M5P09-D9F0-D9F0	10
	FX2NC	CPU	RS422	C3M5P08-D9F0-M8M0	9
	FX2N	CPU	RS422	C3M5P08-D9F0-M8M0	9
RS232C module(FX2N-232-BD)		RS232C	C3M5P09-D9F0-D9F0	10	
FX3U	CPU	RS422	C3M5P08-D9M0-M8M1	19	
MITSUBISHI Q	Q00J	Expansion module(QJ71C24N)	RS232C	C3M5P05-D9F0-D9M0	6
			RS422	C3M5P04-D9M0-W6*0	5
		Expansion module(QJ71C24N-R2)	RS232C	C3M5P05-D9F0-D9M0	6
	Q00	Expansion module(QJ71C24N-R4)	RS422	C3M5P04-D9M0-W6*0	5
		Expansion module(QJ71C24N)	RS232C	C3M5P05-D9F0-D9M0	6
			RS422	C3M5P04-D9M0-W6*0	5
	Q01	Expansion module(QJ71C24N-R2)	RS232C	C3M5P05-D9F0-D9M0	6
		Expansion module(QJ71C24N)	RS422	C3M5P04-D9M0-W6*0	5
		Expansion module(QJ71C24N-R4)	RS232C	C3M5P05-D9F0-D9M0	6
	Q02	Expansion module(QJ71C24N)	RS422	C3M5P04-D9M0-W6*0	5
		Expansion module(QJ71C24N-R2)	RS232C	C3M5P05-D9F0-D9M0	6
		Expansion module(QJ71C24N-R4)	RS422	C3M5P04-D9M0-W6*0	5
	Q02H	Expansion module(QJ71C24N)	RS232C	C3M5P05-D9F0-D9M0	6
		Expansion module(QJ71C24N-R2)	RS422	C3M5P04-D9M0-W6*0	5
		Expansion module(QJ71C24N-R4)	RS232C	C3M5P05-D9F0-D9M0	6
	Q06H	Expansion module(QJ71C24N)	RS422	C3M5P04-D9M0-W6*0	5
		Expansion module(QJ71C24N-R2)	RS232C	C3M5P05-D9F0-D9M0	6
		Expansion module(QJ71C24N-R4)	RS422	C3M5P04-D9M0-W6*0	5
	Q12H	Expansion module(QJ71C24N)	RS232C	C3M5P05-D9F0-D9M0	6
		Expansion module(QJ71C24N-R2)	RS422	C3M5P04-D9M0-W6*0	5
		Expansion module(QJ71C24N-R4)	RS232C	C3M5P05-D9F0-D9M0	6
	Q25H	Expansion module(QJ71C24N)	RS422	C3M5P04-D9M0-W6*0	5
		Expansion module(QJ71C24N-R2)	RS232C	C3M5P05-D9F0-D9M0	6
		Expansion module(QJ71C24N-R4)	RS422	C3M5P04-D9M0-W6*0	5
NAIS FP	FP0-C16	CPU(Tool port)	RS232C	C3M5P10-D9F0-M5M0	11
		CPU(COM port)	RS232C	C3M5P11-D9F0-W4*0	12
	FP0-C32	CPU(Tool port)	RS232C	C3M5P10-D9F0-M5M0	11
		CPU(COM port)	RS232C	C3M5P11-D9F0-W4*0	12
	FP0-T32C	CPU(Tool port)	RS232C	C3M5P10-D9F0-M5M0	11
		CPU(COM port)	RS232C	C3M5P11-D9F0-W4*0	12
	FPG-C24R2	CPU(Tool port)	RS232C	C3M5P10-D9F0-M5M0	11
		CPU(COM port)	RS232C	C3M5P11-D9F0-W4*0	12
	FPG-C32T	CPU(Tool port)	RS232C	C3M5P10-D9F0-M5M0	11
		CPU(COM port)	RS232C	C3M5P11-D9F0-W4*0	12
	FPG-C32T2	CPU(Tool port)	RS232C	C3M5P10-D9F0-M5M0	11
		CPU(COM port)	RS232C	C3M5P11-D9F0-W4*0	12
FP0R-C10	CPU(Tool port)	RS232C	C3M5P10-D9F0-M5M0	11	
	CPU(COM port)	RS232C	C3M5P11-D9F0-W4*0	12	

GP/LP Communication Cable

■ Communication cable by connectable device

Series	Connectable device	Connectable module	Connection type	Communication cable model	Connection diagram no.
NAIS FP	FP0R-C14	CPU (Tool port)	RS232C	C3M5P10-D9F0-M5M0	11
		CPU (COM port)	RS232C	C3M5P11-D9F0-W4*0	12
	FP0R-C16	CPU (Tool port)	RS232C	C3M5P10-D9F0-M5M0	11
		CPU (COM port)	RS232C	C3M5P11-D9F0-W4*0	12
	FP0R-C32	CPU (Tool port)	RS232C	C3M5P10-D9F0-M5M0	11
		CPU (COM port)	RS232C	C3M5P11-D9F0-W4*0	12
	FP0R-T32	CPU (Tool port)	RS232C	C3M5P10-D9F0-M5M0	11
		CPU (COM port)	RS232C	C3M5P11-D9F0-W4*0	12
	FP0R-F32	CPU (Tool port)	RS232C	C3M5P10-D9F0-M5M0	11
		CPU (COM port)	RS232C	C3M5P11-D9F0-W4*0	12
SIEMENS SIMATIC S7-200	CPU221	CPU	RS485	Exclusive cable for SIEMENS	*
	CPU222	CPU	RS485	Exclusive cable for SIEMENS	*
	CPU224	CPU	RS485	Exclusive cable for SIEMENS	*
	CPU224XP	CPU	RS485	Exclusive cable for SIEMENS	*
	CPU224XPsi	CPU	RS485	Exclusive cable for SIEMENS	*
AllenBradley	MicroLogix 1000	CPU	RS485	Exclusive cable for AllenBradley	*
	MicroLogix 1200	CPU	RS485	Exclusive cable for AllenBradley	*
OMRON SYSMAC C	CPM1A	CPU	RS232C	For communicate GP, OMRON사 CQM1-CIF02	*
				For extension cable, C3M5P12-D9F0-D9M1	13
OMRON temperature controller	E5AN	Modbus	RS232C	C3M5P13-D9F0-T4Y0	14
			RS485	C3M5P03-D9M0-T4Y0	15
	E5AR	Modbus	RS485	C3M5P03-D9M0-T4Y0	15
	E5CN	Modbus	RS485	C3M5P03-D9M0-T4Y0	15
	E5EN	Modbus	RS232C	C3M5P13-D9F0-T4Y0	14
			RS485	C3M5P03-D9M0-T4Y0	15
E5ER	Modbus	RS485	C3M5P03-D9M0-T4Y0	15	
Autonics	MT Series	Private communication, Modbus	RS485	C3M5P03-D9M0-W4*0	4
	MP Series	Private communication	RS485	C3M5P03-D9M0-W4*0	4
	THD Series	Modbus	RS485	C3M5P03-D9M0-W4*0	4
	TZ Series	Private communication	RS485	C3M5P03-D9M0-T4Y0	15
	TK Series	Modbus	RS485	C3M5P03-D9M0-T4Y0	15
	TM Series	Modbus	RS485	C3M5P03-D9M0-T4Y0	15
	CT Series	Modbus	RS485	C3M5P03-D9M0-T4Y0	15
	LP-S044 Series	CPU	RS232C	C3M5P14-D9F0-D9F0	17
RS422			C3M5P15-D9M0-D9M0	18	
KONICS	DPU Series	Modbus	RS485	C3M5P03-D9M0-W4*0	4
	KRN50 Series	Modbus	RS485	C3M5P03-D9M0-W4*0	4
DELTA	DTB Series	Modbus	RS485	C3M5P03-D9M0-T4Y0	15
GP firmware download cable	COMPUTER	*	RS232C	C3M5P14-D9F0-D9F0	17

- (A) Photo electric sensor
- (B) Fiber optic sensor
- (C) Door/Area sensor
- (D) Proximity sensor
- (E) Pressure sensor
- (F) Rotary encoder
- (G) Connector/Socket
- (H) Temp. controller
- (I) SSR/Power controller
- (J) Counter
- (K) Timer
- (L) Panel meter
- (M) Tacho/Speed/Pulse meter
- (N) Display unit
- (O) Sensor controller
- (P) Switching power supply
- (Q) Stepping motor & Driver & Controller
- (R) Graphic/Logic panel
- (S) Field network device
- (T) Production stoppage models & replacement